

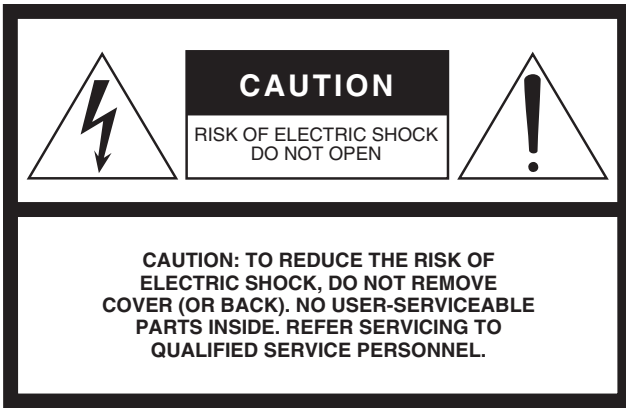

MATRIX PROCESSOR

MTX3

Owner's Manual



The above warning is located on the top of the unit.

Explanation of Graphical Symbols

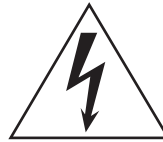

The lightning flash with arrowhead symbol within an equilateral triangle is intended to alert the user to the presence of uninsulated “dangerous voltage” within the product’s enclosure that may be of sufficient magnitude to constitute a risk of electric shock to persons.



The exclamation point within an equilateral triangle is intended to alert the user to the presence of important operating and maintenance (servicing) instructions in the literature accompanying the product.

IMPORTANT SAFETY INSTRUCTIONS

- 1 Read these instructions.
- 2 Keep these instructions.
- 3 Heed all warnings.
- 4 Follow all instructions.
- 5 Do not use this apparatus near water.
- 6 Clean only with dry cloth.
- 7 Do not block any ventilation openings. Install in accordance with the manufacturer’s instructions.
- 8 Do not install near any heat sources such as radiators, heat registers, stoves, or other apparatus (including amplifiers) that produce heat.
- 9 Do not defeat the safety purpose of the polarized or grounding-type plug. A polarized plug has two blades with one wider than the other. A grounding type plug has two blades and a third grounding prong. The wide blade or the third prong are provided for your safety. If the provided plug does not fit into your outlet, consult an electrician for replacement of the obsolete outlet.
- 10 Protect the power cord from being walked on or pinched particularly at plugs, convenience receptacles, and the point where they exit from the apparatus.
- 11 Only use attachments/accessories specified by the manufacturer.
- 12 Use only with the cart, stand, tripod, bracket, or table specified by the manufacturer, or sold with the apparatus. When a cart is used, use caution when moving the cart/apparatus combination to avoid injury from tip-over.
- 13 Unplug this apparatus during lightning storms or when unused for long periods of time.
- 14 Refer all servicing to qualified service personnel. Servicing is required when the apparatus has been damaged in any way, such as power-supply cord or plug is damaged, liquid has been spilled or objects have fallen into the apparatus, the apparatus has been exposed to rain or moisture, does not operate normally, or has been dropped.



WARNING

TO REDUCE THE RISK OF FIRE OR ELECTRIC SHOCK, DO NOT EXPOSE THIS APPARATUS TO RAIN OR MOISTURE.

(UL60065_03)

FCC INFORMATION (U.S.A.)

1. IMPORTANT NOTICE: DO NOT MODIFY THIS UNIT!

This product, when installed as indicated in the instructions contained in this manual, meets FCC requirements. Modifications not expressly approved by Yamaha may void your authority, granted by the FCC, to use the product.

2. **IMPORTANT:** When connecting this product to accessories and/or another product use only high quality shielded cables. Cable/s supplied with this product **MUST** be used. Follow all installation instructions. Failure to follow instructions could void your FCC authorization to use this product in the USA.

3. **NOTE:** This product has been tested and found to comply with the requirements listed in FCC Regulations, Part 15 for Class "B" digital devices. Compliance with these requirements provides a reasonable level of assurance that your use of this product in a residential environment will not result in harmful interference with other electronic devices. This equipment generates/uses radio frequencies and, if not installed and used according to the instructions found in the users manual, may cause interference harmful to the operation of other electronic devices. Compliance with FCC regulations does not guarantee that interference will not occur in

all installations. If this product is found to be the source of interference, which can be determined by turning the unit "OFF" and "ON", please try to eliminate the problem by using one of the following measures:

Relocate either this product or the device that is being affected by the interference.

Utilize power outlets that are on different branch (circuit breaker or fuse) circuits or install AC line filter/s.

In the case of radio or TV interference, relocate/reorient the antenna. If the antenna lead-in is 300 ohm ribbon lead, change the lead-in to co-axial type cable.

If these corrective measures do not produce satisfactory results, please contact the local retailer authorized to distribute this type of product. If you can not locate the appropriate retailer, please contact Yamaha Corporation of America, Electronic Service Division, 6600 Orangethorpe Ave, Buena Park, CA90620

The above statements apply **ONLY** to those products distributed by Yamaha Corporation of America or its subsidiaries.

* This applies only to products distributed by YAMAHA CORPORATION OF AMERICA.

(class B)

IMPORTANT NOTICE FOR THE UNITED KINGDOM Connecting the Plug and Cord

WARNING: THIS APPARATUS MUST BE EARTHED IMPORTANT. The wires in this mains lead are coloured in accordance with the following code:

GREEN-AND-YELLOW : EARTH
BLUE : NEUTRAL
BROWN : LIVE

As the colours of the wires in the mains lead of this apparatus may not correspond with the coloured markings identifying the terminals in your plug proceed as follows:

The wire which is coloured GREEN-and-YELLOW must be connected to the terminal in the plug which is marked by the letter E or by the safety earth symbol  or colored GREEN or GREEN-and-YELLOW.

The wire which is coloured BLUE must be connected to the terminal which is marked with the letter N or coloured BLACK.

The wire which is coloured BROWN must be connected to the terminal which is marked with the letter L or coloured RED.

(3 wires)

COMPLIANCE INFORMATION STATEMENT (DECLARATION OF CONFORMITY PROCEDURE)

Responsible Party : Yamaha Corporation of America
Address : 6600 Orangethorpe Ave., Buena Park,
Calif. 90620

Telephone : 714-522-9011

Type of Equipment : Matrix Processor

Model Name : MTX3

This device complies with Part 15 of the FCC Rules.

Operation is subject to the following two conditions:

- 1) this device may not cause harmful interference, and
- 2) this device must accept any interference received including interference that may cause undesired operation.

See user manual instructions if interference to radio reception is suspected.

* This applies only to products distributed by
YAMAHA CORPORATION OF AMERICA.

(FCC DoC)

ADVARSEL!

Lithiumbatteri—Eksplussionsfare ved fejlagtig håndtering. Udskiftning må kun ske med batteri af samme fabrikat og type. Levér det brugte batteri tilbage til leverandoren.

VARNING

Explosionsfara vid felaktigt batteribyte. Använd samma batterityp eller en ekvivalent typ som rekommenderas av apparattillverkaren. Kassera använt batteri enligt fabrikantens instruktion.

VAROITUS

Paristo voi räjähtää, jos se on virheellisesti asennettu. Vaihda paristo ainoastaan laitevalmistajan suosittelemaan tyyppiin. Hävitä käytetty paristo valmistajan ohjeiden mukaisesti.

(lithium caution)

NEDERLAND / THE NETHERLANDS

- Dit apparaat bevat een lithium batterij voor geheugen back-up.
- This apparatus contains a lithium battery for memory back-up.
- Raadpleeg uw leverancier over de verwijdering van de batterij op het moment dat u het apparaat aan het einde van de levensduur of gelieve dan contact op te nemen met de vertegenwoordiging van Yamaha in uw land.
- For the removal of the battery at the moment of the disposal at the end of life please consult your retailer or Yamaha representative office in your country.
- Gooi de batterij niet weg, maar lever hem in als KCA.
- Do not throw away the battery. Instead, hand it in as small chemical waste.

(lithium disposal)

This product contains a battery that contains perchlorate material. Perchlorate Material—special handling may apply, See www.dtsc.ca.gov/hazardouswaste/perchlorate.

* This applies only to products distributed
by YAMAHA CORPORATION OF AMERICA.

(Perchlorate)

이 기기는 가정용(B급) 전자파적합기기로서 주로 가정에서 사용하는 것을 목적으로 하며, 모든 지역에서 사용할 수 있습니다.

(class b korea)

PRECAUTIONS

PLEASE READ CAREFULLY BEFORE PROCEEDING

* Please keep this manual in a safe place for future reference.

WARNING

Always follow the basic precautions listed below to avoid the possibility of serious injury or even death from electrical shock, short-circuiting, damages, fire or other hazards. These precautions include, but are not limited to, the following:

Power supply/Power cord

- Do not place the power cord near heat sources such as heaters or radiators, and do not excessively bend or otherwise damage the cord, place heavy objects on it, or place it in a position where anyone could walk on, trip over, or roll anything over it.
- Only use the voltage specified as correct for the device. The required voltage is printed on the name plate of the device.
- Use only the supplied power cord/plug.
If you intend to use the device in an area other than in the one you purchased, the included power cord may not be compatible. Please check with your Yamaha dealer.
- Check the electric plug periodically and remove any dirt or dust which may have accumulated on it.
- Be sure to connect to an appropriate outlet with a protective grounding connection. Improper grounding can result in electrical shock.

Do not open

- This device contains no user-serviceable parts. Do not open the device or attempt to disassemble the internal parts or modify them in any way. If it should appear to be malfunctioning, discontinue use immediately and have it inspected by qualified Yamaha service personnel.

Water warning

- Do not expose the device to rain, use it near water or in damp or wet conditions, or place on it any containers (such as vases, bottles or glasses) containing liquids which might spill into any openings. If any liquid such as water seeps into the device, turn off the power immediately and unplug the power cord from the AC outlet. Then have the device inspected by qualified Yamaha service personnel.
- Never insert or remove an electric plug with wet hands.

Fire warning

- Do not put burning items, such as candles, on the unit. A burning item may fall over and cause a fire.

If you notice any abnormality

- When one of the following problems occur, immediately turn off the power switch and disconnect the electric plug from the outlet. Then have the device inspected by Yamaha service personnel.
 - The power cord or plug becomes frayed or damaged.
 - It emits unusual smells or smoke.
 - Some object has been dropped into the instrument.
 - There is a sudden loss of sound during use of the device.
- If this device should be dropped or damaged, immediately turn off the power switch, disconnect the electric plug from the outlet, and have the device inspected by qualified Yamaha service personnel.

CAUTION

Always follow the basic precautions listed below to avoid the possibility of physical injury to you or others, or damage to the device or other property. These precautions include, but are not limited to, the following:

Power supply/Power cord

- When removing the electric plug from the device or an outlet, always hold the plug itself and not the cord. Pulling by the cord can damage it.
- Remove the electric plug from the outlet when the device is not to be used for extended periods of time, or during electrical storms.

Location

- Do not place the device in an unstable position where it might accidentally fall over.
- Do not block the vents. This device has ventilation holes at the front and sides to prevent the internal temperature from becoming too high. In particular, do not place the device on its side or upside down. Inadequate ventilation can result in overheating, possibly causing damage to the device(s), or even fire.
- Do not place the device in a location where it may come into contact with corrosive gases or salt air. Doing so may result in malfunction.
- Before moving the device, remove all connected cables.
- When setting up the device, make sure that the AC outlet you are using is easily accessible. If some trouble or malfunction occurs, immediately turn off the power switch and disconnect the plug from the outlet. Even when the power switch is turned off, electricity is still flowing to the product at the minimum level. When you are not using the product for a long time, make sure to unplug the power cord from the wall AC outlet.
- If the device is mounted in an EIA standard rack, carefully read the section "Precautions for rackmounting" on page 7. Inadequate ventilation can result in overheating, possibly causing damage to the device(s), malfunction, or even fire.
- Keep device away from the reach of children.

Connections

- Before connecting the device to other devices, turn off the power for all devices. Before turning the power on or off for all devices, set all volume levels to minimum.

Maintenance

- Remove the power plug from the AC outlet when cleaning the device.

Handling caution

- Do not insert your fingers or hands in any gaps or openings on the device (vents).
- Avoid inserting or dropping foreign objects (paper, plastic, metal, etc.) into any gaps or openings on the device (vents). If this happens, turn off the power immediately and unplug the power cord from the AC outlet. Then have the device inspected by qualified Yamaha service personnel.
- Do not rest your weight on the device or place heavy objects on it, and avoid use excessive force on the buttons, switches or connectors.
- Do not use the device/speakers for a long period of time at a high or uncomfortable volume level, since this can cause permanent hearing loss. If you experience any hearing loss or ringing in the ears, consult a physician.

Backup battery

- This device has a built-in backup battery. When you unplug the power cord from the AC outlet, the internal data is retained. However, if the backup battery fully discharges, this data will be lost. When the backup battery is running low, the [PRESET] display indicates "12." In this case, immediately save the data to external device such as a computer, then have qualified Yamaha service personnel replace the backup battery.

Yamaha cannot be held responsible for damage caused by improper use or modifications to the device, or data that is lost or destroyed.

Always turn the power off when the device is not in use.

NOTICE

To avoid the possibility of malfunction/ damage to the product, damage to data, or damage to other property, follow the notices below.

■ Handling and Maintenance

- Do not use the device in the vicinity of a TV, radio, stereo equipment, mobile phone, or other electric devices. Otherwise, the device, TV, or radio may generate noise.
- Do not expose the device to excessive dust or vibration, or extreme cold or heat (such as in direct sunlight, near a heater, or in a car during the day), in order to prevent the possibility of panel disfiguration, unstable operation, or damage to the internal components.
- Do not place vinyl, plastic or rubber objects on the device, since this might discolor the panel.
- When cleaning the device, use a dry and soft cloth. Do not use paint thinners, solvents, cleaning fluids, or chemical-impregnated wiping cloths.
- Condensation can occur in the device due to rapid, drastic changes in ambient temperature—when the device is moved from one location to another, or air conditioning is turned on or off, for example. Using the device while condensation is present can cause damage. If there is reason to believe that condensation might have occurred, leave the device for several hours without turning on the power until the condensation has completely dried out.
- When turning on the AC power in your audio system, always turn on the power amplifier LAST, to avoid speaker damage. When turning the power off, the power amplifier should be turned off FIRST for the same reason.

■ Saving data

This device has a built-in backup battery that maintains data in internal memory even when the device's power is switched off. The backup battery will eventually become depleted, however, and when that happens the contents of the internal memory will be lost.* To prevent loss of data be sure to replace the backup battery before it becomes fully depleted. If the backup battery runs low, alert number "12." will appear in the [PRESET] display either while the unit is starting up. If this occurs, do not turn off the power, but immediately save the data to a computer or other external storage device, and then have qualified Yamaha service personnel replace the backup battery. The average life of the internal backup battery is approximately five years, depending on operating conditions.

* Data items maintained in the internal memory by the backup battery are as follows:

- Contents of the current preset and the preset number
- Parameters specific to the unit (e.g., configuration data)
- Current parameters for peripheral devices within the same system
- Event log

Data items other than those described above are stored in memory that does not require backup power, and will be retained even if the backup battery fails.

Information

■ About this manual

- The illustrations as shown in this manual are for instructional purposes only, and may appear somewhat different from those on your device.
- Ethernet is a trademark of Xerox Corporation.
- Windows is a registered trademark of Microsoft® Corporation in the United States and other countries.
- SDHC Logo and SD Logo are trademarks of SD-3C, LLC.



- The company names and product names in this manual are the trademarks or registered trademarks of their respective companies.
- MPEG Layer-3 audio coding technology licensed from Fraunhofer IIS and Thomson.



Information for Users on Collection and Disposal of Old Equipment

This symbol on the products, packaging, and/or accompanying documents means that used electrical and electronic products should not be mixed with general household waste. For proper treatment, recovery and recycling of old products, please take them to applicable collection points, in accordance with your national legislation and the Directives 2002/96/EC.

By disposing of these products correctly, you will help to save valuable resources and prevent any potential negative effects on human health and the environment which could otherwise arise from inappropriate waste handling.

For more information about collection and recycling of old products, please contact your local municipality, your waste disposal service or the point of sale where you purchased the items.

[For business users in the European Union]

If you wish to discard electrical and electronic equipment, please contact your dealer or supplier for further information.

[Information on Disposal in other Countries outside the European Union]

This symbol is only valid in the European Union. If you wish to discard these items, please contact your local authorities or dealer and ask for the correct method of disposal.

(weee_eu_en_01)

Contents

PRECAUTIONS	4
Getting Started	7
Included items (please check)	7
Firmware versions.....	7
Precautions for rackmounting.....	7
Introducing the MTX3	8
Features.....	8
About MTX Editor	8
Using the PDF manual.....	8
Controls and Connectors	9
Front Panel.....	9
Rear Panel	10
Euroblock plug connection.....	12
Quick Guide	14
Preparations.....	14
On-site work (Installation and wiring)	15
On-site work (Settings in MTX Editor).....	16
Various Procedures	17
Recalling (switching) presets	17
Switching presets from the MTX3	17
Setting the clock.....	17
Using the scheduler	17
Connecting via the [GPI] connector	18
Using the MTX3 to play audio files saved on an SD memory card	19
Inserting an SD memory card.....	19
Removing the SD memory card.....	19
Initializing the MTX3	19
Appendix	21
Troubleshooting.....	21
Alert list.....	22
Specifications.....	23
Input/Output Characteristics	24
Dimensions	24
Block Diagram.....	25
Index	26

Getting Started

Thank you for purchasing the Yamaha Matrix Processor MTX3. This manual will help you take full advantage of the superior functionality offered by the MTX3. After you have read the manual, keep it in a safe place for reference when needed.

Included items (please check)

- MTX3 Owner's Manual (this document)
- Power cable
- Euroblock plug (16-pin, 3.50mm pitch) (1)
- Euroblock plugs (3-pin, with tab, 5.08mm pitch) (16)
- Cable ties (16)

Firmware versions

Use MTX Editor to update the firmware of the MTX3 or check the firmware version. For details on operation, refer to the MTX Editor User's Manual.

Download the latest firmware from the "Downloads" page on the following website.

<http://www.yamahaproaudio.com/>

Precautions for rackmounting

This device is guaranteed to operate at an ambient temperature of 0 to 40 °C. If this device is mounted in an EIA rack together with other devices, heat from the various devices may cause the temperature inside the rack to rise, rendering this device unable to perform to its full potential. To ensure that heat does not accumulate inside this device, please ensure that the following conditions are met when rack-mounting it.

- If you plan to mount this device together with devices that tend to generate heat, such as power amps other than XMV series products, allow 1U or more of vacant space between this device and other devices. Also attach ventilation panels in this space or leave them open to ensure sufficient ventilation.
- Leave the back of the rack open, and allow at least 10 cm of space between the rack and the wall or ceiling to ensure sufficient ventilation. If the back of the rack cannot be left open, provide forced air cooling for the rack, for example by installing a commercially available fan kit. If you install a fan kit, leaving the back of the rack closed may provide more effective cooling. For details, refer to the owner's manual provided with the rack or fan kit.

Introducing the MTX3

Features

- **A signal processor suitable for small or mid-sized installed systems**

The MTX3 is a signal processor suitable for small or mid-sized systems such as retail establishments or banquet halls. In addition to a 26 ch. x 8 ch. matrix mixer, it provides 3-band parametric EQ, compressor/gate, auto gain control, eight priority duckers, and four feedback suppressors. For the output stages, it provides numerous high-performance high-quality processors, such as 4-band parametric EQ, delay, and speaker processor.

- **Newly-developed “YDIF” digital audio transmission format**

“YDIF” is a digital audio transmission format that uses Ethernet cable to send and receive up to 16 channels of audio and word clock. You can use Ethernet cables up to 30 meters long to easily make connections between devices.

- **Versatile input/output and SD memory card slot**

In addition to eight high-quality monaural mic/line inputs and two stereo line inputs, digital input/output via “YDIF” can allow up to 16 channels of input. An SD memory card slot for playback is also provided; allowing MP3/WAV audio files saved on the SD memory card to be played back. In addition to eight channels of analog monaural output, a maximum of 16 channels of digital audio can be output via a “YDIF” connection.

- **Support for external controls**

By connecting a “DCP” series dedicated wall-mounted control panel to the [DCP] connector, you can easily control the volume of multiple zones or switch presets. Daisy-chain connection via Ethernet cable allows up to eight “DCP” series control panels to be connected. The total cable length from the MTX3 to the farthest control panel can be up to 200 meters, and power is also supplied, allowing you to place the control panel in the ideal location for the room. A NETWORK connector and [GPI] connector are also provided for controlling the unit from an AMX/Crestron or other touch panel device.

- **Two built-in effect processors**

Two effect processors are built-in, and can be easily used in a party room or banquet hall. You can easily obtain effects such as reverb or karaoke echo without needing to add dedicated effect processors.

- **Dedicated “MTX Editor” application software for designing the entire system**

“MTX Editor” is application software for editing the parameters of the MTX3. Using operating screens that reflect the workflow of designing the installation, this software makes it easy to design a system and make (or adjust) settings. A speaker library of Yamaha-manufactured speakers is also built-in, making it easy to choose settings that will maximize the performance of your speakers.

- **iPhone app support**

A dedicated iPhone app makes it easy to control the volume and manage presets in the same way as when using the dedicated wall-mounted control panel. You can use your iPhone/iPod touch to easily control the sound system of a retail location or a banquet hall.

About MTX Editor

MTX Editor is software for the Windows operating system that allows unified construction and control of systems that use the MTX series.

MTX Editor and the MTX Editor User’s Manual can be downloaded from the following website.

<http://www.yamahaproaudio.com/>

For details on installing MTX Editor and connecting the MTX3 to your computer, refer to the “MTX Setup Manual.”

Using the PDF manual

The MTX Editor User’s Manual is an electronic file in PDF format. You can read this book on a computer. Use Adobe® Reader® to read this book on screen, search for words very quickly, print specific pages, or click links to display sections of special interest. The ability to search for words, or to follow links directly to relevant sections in the document, are helpful attributes of this electronic file format. We encourage you to take advantage of these benefits.

You can download the latest Adobe Reader application from the website listed below.

<http://www.adobe.com/>

Controls and Connectors

Front Panel

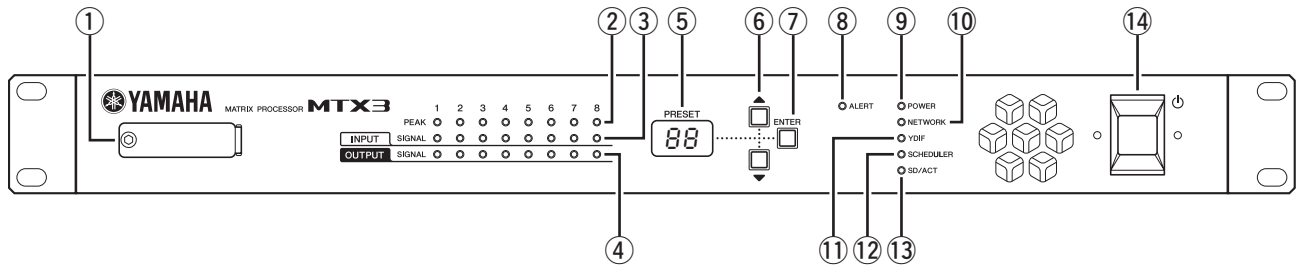

① SD memory card slot

You can insert an SD memory card here. Music or sound effects can be played back from an SD memory card containing audio files (MP3 files and WAV files). Before you insert an SD memory card into the slot, or remove an SD memory card from the slot, remove the slot cover.

For details on SD memory card handling, refer to page 19. For details on how to play back audio files, refer to the MTX Editor User's Manual.

② [INPUT PEAK] indicators 1–8

These indicators will light red when the input level of the corresponding INPUT channel is -3 dBFS or higher.

③ [INPUT SIGNAL] indicators 1–8

These indicators will light green when the input level of the corresponding INPUT channel is -40 dBFS or higher.

④ [OUTPUT SIGNAL] indicators 1–8

These indicators will light green when the output level of the corresponding OUTPUT channel is -40 dBFS or higher.

⑤ [PRESET] display

This display usually shows the preset number. It can also show the UNIT ID, alert number, or a message.

⑥ [▲]/[▼] buttons

Use these buttons to change the preset number or alert number shown in the above [PRESET] display.

⑦ [ENTER] button

Use this button to confirm the item shown in the above [PRESET] display.

When an alert number is shown, pressing this button will return to the preset number display.

⑧ [ALERT] indicator

When an alert occurs, the [PRESET] display will indicate the alert number and this indicator will flash red.

⑨ [POWER] indicator

This indicator will light when this device is powered-on.

⑩ [NETWORK] indicator

This indicator will light green if a link is established with an external device via the rear panel NETWORK connector (page 10). It will flash while data is being sent or received.

⑪ [YDIF] indicator

This indicator will light green if the rear panel [YDIF IN] connector (page 11) is correctly connected to the [YDIF OUT] connector of another device.



⑫ [SCHEDULER] indicator

This indicator will light yellow if an event has been specified in the scheduler (page 17), and will start flashing one minute before the event.

⑬ [SD/ACT] indicator

This indicator will light yellow if an SD memory card is inserted in the SD memory card slot (①) and has been detected correctly. It will flash while the SD memory card is being accessed.

⑭ Power switch

This is the power switch. The power is on if the switch is in the  position. The power is off if the switch is in the  position.

NOTE

- Do not cycle the power switch in rapid succession. Wait at least 6 seconds before turning the power switch on after it has been turned off. Failing to observe this precaution may cause malfunctions.
- Even when the power switch is turned off, a small amount of current is flowing through the unit. If you plan not to use the unit for a long period of time, remove the power cable from the AC outlet.

Rear Panel

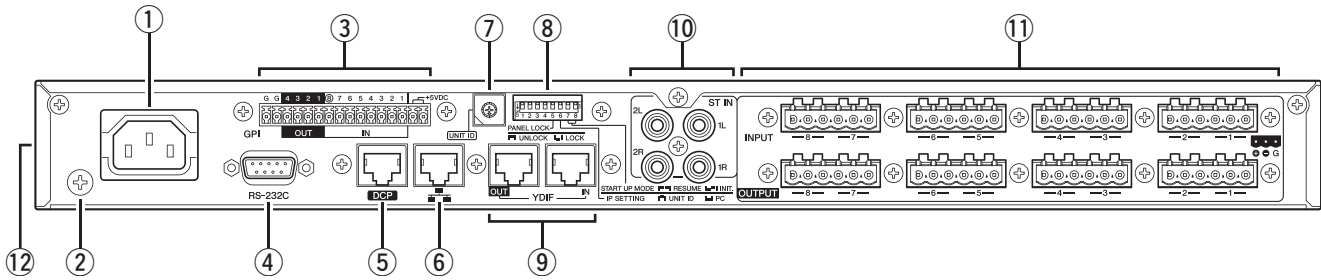

NOTE

The MTX3 has some connectors that are shaped identically but have a completely different function (e.g., [DCP] connector, NETWORK connector, [YDIF] connector). Make the appropriate connections as instructed by the explanation for each connector. Otherwise, you risk damaging your equipment.

① **AC IN connector**

Use the included power cord to supply power to this connector. First, connect the power cord to this device, and then insert the power cord plug into the AC outlet.

② **Ground screw**

The supplied power cord has a three-prong plug that will ground the device when plugged into an appropriately grounded three-prong type AC mains outlet. In some cases, you may be able to reduce hum or interference by also connecting this screw to ground.

③ **[GPI] connector**

This Euroblock connector allows input and output of control signals via GPI (General Purpose Interface). The MTX3 provides seven ports of analog/digital input, one port of digital input, and four ports of output. The [IN]-1–7 terminals detect voltage changes from 0V to 5V. The [IN]-8 terminal alone supports +24V input; voltages in the range of 2.5–24V are detected as High, and voltages below 2.5V are detected as Low. The [OUT]-1–4 terminals are open collector outputs; they will change between open or closed (Ground). The +5VDC terminals has an output voltage of 5V. Use the included Euroblock plugs to make connections (see “Euroblock plug connection” on page 12 for details). For details on connections and usage, refer to “Connecting via the [GPI] connector” on page 18.

CAUTION

Do not input a voltage higher than 5V to the [IN]-1–7 pins. Doing so may damage your equipment.

④ **[RS-232C] connector**

This 9-pin D-SUB connector allows connection to an RS-232C compatible controller such as those from AMX or Crestron.

⑤ **[DCP] connector**

Use this connector to daisy-chain separately sold control panels such as the DCP1V4S to control the MTX3. Use a CAT5e or better Ethernet straight cable that has all eight pins connected.

Up to eight control panels can be connected to one MTX3. The total length of the cables from the MTX3 to the last control panel must not exceed 200 meters.

CAUTION

- Do not connect a control panel to any connector other than the MTX3’s [DCP] connector. Since the control panel is not electrically compatible, such connections may cause fire or malfunction.
- Never connect any device to the [DCP] connector other than the separately sold DCP or other control panel. Doing so may damage the other device or this device.

⑥ **NETWORK connector**

This is an Ethernet connector that supports AutoMDI/MDI-X. It can either be connected directly to a computer, or via a network switch to communicate with a computer, peripheral device, or external controller. Use a CAT5e or better Ethernet STP cable (shielded twisted pair cable).

⑦ **[UNIT ID] rotary switch**

When multiple devices are connected within the same network, this switch specifies the ID by which MTX3 devices are individually distinguished. DIP switches 1 and 2 described below specify the upper digit, and this rotary switch specifies the lower digit, together allowing you to set the UNIT ID to one of 63 possibilities in the range of 01 to 3F.

NOTE

- Do not use a UNIT ID of “00” (DIP switches 1 and 2 OFF and the rotary switch at 0).
- You’ll need to restart the device after changing the setting of the [UNIT ID] rotary switch.

⑧ **DIP switches**

These switches enable you to specify the settings related to the startup operation of the unit.

NOTE





Set the DIP switches while the power to the unit is turned OFF. Otherwise, the setting will not be effective.

Refer to the following for details.

Switch	Status
	Represent a status with switch toggled up.
	Represent a status with switch toggled down.

● **Switches 1–2 (UNIT ID)**

These switches specify the upper digit and the above-mentioned [UNIT ID] rotary switch specifies the lower digit, together allowing you to specify one of 63 different UNIT ID numbers in a range from 01 to 3F.

Switch position	Option	Functions
	UNIT ID is "0x"	The [UNIT ID] rotary switch will have a setting range of 01 through 0F.
	UNIT ID is "1x"	The [UNIT ID] rotary switch will have a setting range of 10 through 1F.
	UNIT ID is "2x"	The [UNIT ID] rotary switch will have a setting range of 20 through 2F.
	UNIT ID is "3x"	The [UNIT ID] rotary switch will have a setting range of 30 through 3F.

NOTE



Do not use a UNIT ID of "00" (DIP switches 1 and 2 OFF and the rotary switch at 0).

● **Switches 3–4**

Not used. Turn it off (up) at any time.



● **Switch 5 (PANEL LOCK)**

This switch locks the front panel controls. Use this if you want to prevent accidental operation from the front panel.

Switch position	Option	Functions
	UNLOCK	The front panel controls will be available for operation.
	LOCK	The front panel controls will be locked, and will be inoperable. The device can be operated from a computer or an external controller.

● **Switch 6 (IP SETTING)**

This switch specifies how the MTX3's IP address will be specified.



Switch position	Option	Functions
	UNIT ID	The IP address will be specified according to the UNIT ID, and will be 192.168.0.(UNIT ID).
	PC	The IP address will be determined by the settings of MTX Editor. (See "MTX Editor User's Manual.")

NOTE

You must set this to the "UNIT ID" position the first time you connect this device to a computer after purchase. If you subsequently want to specify the IP address instead of using the UNIT ID, specify the IP address from MTX Editor and then switch this setting to the "PC" position.

● **Switches 7–8 (START UP MODE)**

These specify whether the MTX3 will be initialized when it is powered-on.

Switch position	Option	Functions
	RESUME	This is the normal operating mode. When you power-on the MTX3, it will start up in the same state in which it was when the power was turned off.
	INIT. (INITIALIZE)	Initializes the MTX3, returning it to the factory-set state (page 19).

⑨ **[YDIF] connectors**

These connectors are used to make a ring connection with the devices that comprise the MTX system, allowing digital audio signals to be transmitted and received. Use CAT5e or better Ethernet STP cables (shielded twisted pair cables) that have all eight pins connected in a straight connection. The maximum cable length between devices is 30 meters, and you can connect up to eight devices that are equipped with the [YDIF] connectors. For details, refer to the MTX Editor User's Manual.

⑩ **[ST IN] connectors**

These are unbalanced RCA phono jacks for inputting analog audio signals from a CD player or other device.

⑪ **[INPUT]/[OUTPUT] connectors**

These are balanced input/output connectors for analog audio input and output. Connect line level devices or microphones to the [INPUT] connectors, and line level devices to the [OUTPUT] connectors. The [INPUT] connectors provide head amps, and can also provide +48V phantom power. MTX Editor is used to specify the gain of the internal head amps and to turn the phantom power on/off.

Use the included Euroblock plugs to make connections (see "Euroblock plug connection" on page 12 for details).

NOTE

Adjusting the internal head amp gain between +17 dB and +18 dB will internally turn PAD on/off. Noise may occur if there is an impedance difference between the Hot and Cold of a device connected to the [INPUT] connectors while phantom power is being used.

⑫ **Cooling vent**

The MTX3 contains a cooling fan. The cooling air is exhausted here, so please be careful not to block this vent.

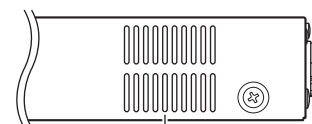

Cooling vent

■ Euroblock plug connection

Use the included Euroblock plugs when making connections to the [INPUT]/[OUTPUT] connectors and [GPI] connector.

Cable preparation

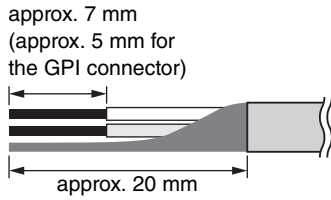

- Use stranded wire for Euroblock connections, and strip the wire as shown in the illustration. With a Euroblock connection, the stranded wire may be prone to breakage because of metal fatigue due to the weight of the cable or due to vibration. Cables connected to the [INPUT]/[OUTPUT] connectors should be fastened to the tab of the Euroblock plug (3-pin) using the included cable ties (see illustration at right). When rack-mounting the device, use a lacing bar when possible to bundle and secure the cable.

NOTE

Do not tin (plate with solder) the stranded wire.

- If cables will be frequently connected and disconnected, as in the case of a portable system, we recommend that you use ferrules with insulation sleeves. Use a ferrule whose conductor portion has an external diameter of 1.6 mm or less (1.3 mm or less for the [GPI] connector) and a length of approximately 7 mm (approximately 5 mm for the [GPI] connector) such as the AI 0,5 - 6 WH made by the Phoenix Contact corporation.

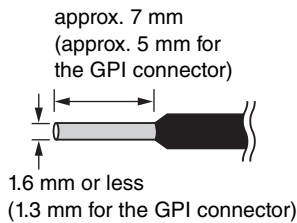

1. Loosen the terminal screws.

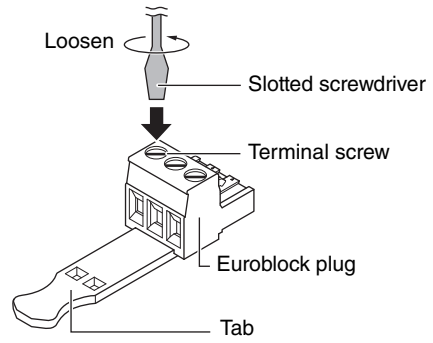

* The explanation uses tabbed Euroblock plugs.

NOTE

Use a slotted screwdriver with a blade width of 2 mm or less for the [GPI] connector's Euroblock plug (16-pin), and a blade width of 3 mm or less for the [INPUT]/[OUTPUT] connector's Euroblock plug (3-pin).

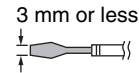

2. Insert cables.

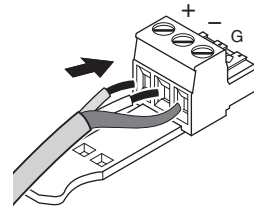

3. Securely tighten the terminal screws.

Pull the cables (not too strongly) to confirm that they are securely connected.

4. For the Euroblock plugs (3-pin) of the [INPUT]/[OUTPUT] connectors, use the included cable ties to fasten the cable to the tab.

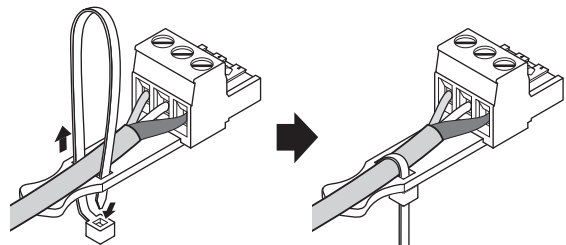

NOTE

Trim off the extra portion of the cable tie as necessary.

5. Plug the Euroblock plug into the [GPI] connector or [INPUT]/[OUTPUT] connector of the MTX3.

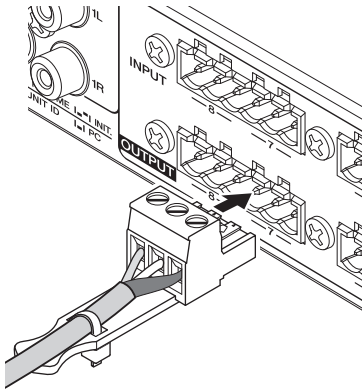
**NOTE**

When connecting unbalanced cables to the [INPUT] connector, use a jumper wire to connect the “-” and “G” of the Euroblock.

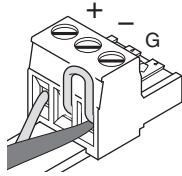

Quick Guide

This section explains basic settings and connection procedures for constructing an MTX system using the MTX3. Some of the steps may not be necessary for your system; if so, proceed to the next step.

Preparations

Use MTX Editor to make the required settings before you actually install and connect the equipment.

1. Prepare a computer in which to install MTX Editor.

2. Install MTX Editor in your computer.

For details on installation, refer to “MTX Setup Manual.”

3. Specify the IP address and subnet mask of your computer.

Enter “192.168.0.253” as the IP address and “255.255.255.0” as the subnet mask.

4. If you want to play back music or other audio files from the MTX3 itself, prepare an SD memory card.

Copy the audio files to your SD memory card. For details on SD memory card handling, refer to “Using the MTX3 to play audio files saved on an SD memory card” (page 19).

5. Start up MTX Editor.

For details on installing and using MTX Editor, refer to “MTX Setup Manual” and “MTX Editor User’s Manual.”

6. Set up the entire MTX system as directed by the wizard.

Make settings such as the number of connected MTX/XMV/Exi8/EXo8/DCP devices, and the UNIT ID and YDIF mode (Cascade mode or Distribution mode) for each device. For details on YDIF, refer to “Features” (page 8), and “⑨ [YDIF] connectors” in “Controls and Connectors” (page 11). Print out the schematic diagram shown at the end of the wizard, and use it when you make the actual connections and settings.

7. The audio signal flow in the MTX3 and the principal parameters to be set are as follows. Make the settings in the order shown.

For details on each item, refer to “MTX Editor User’s Manual.”

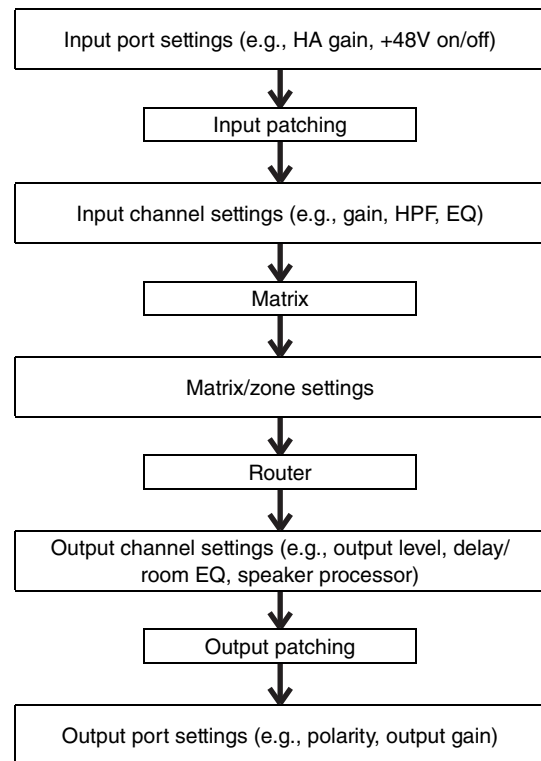

Make settings for the necessary components while offline.

- **HA section:**
HA gain, +48V (phantom power)
- **Input channel section:**
HPF, 3BAND EQ, GATE, COMP, FBS, AGC, Level
- **Matrix/Zone section:**
Two-level priority ducker, ANC
- **Output channel section:**
Room EQ (Delay, 4Band EQ), SPEAKER PROCESSOR (X-over, Delay, 6Band EQ, Level, Limiter)

8. Make DCP settings.

Assign the parameters of the MTX3 to the switches and knobs of the connected DCP units. Here you can also specify the brightness of the DCP's LEDs. For details on how to make DCP settings, refer to "MTX Editor User's Manual."

9. As necessary, make settings for devices other than the MTX3.

For details, refer to "MTX Setup Manual."

10. Specify and store a preset.

You can use presets to change the volume of zones and the audio source to play (e.g., SD memory card or CD player) in a single action. To prevent problems such as a sudden increase in volume when the MTX3 is operated, we recommend that you store the preset with the output level lowered to "-infinity (∞)."

For details on presets and how to recall them, refer to "Recalling (switching) presets" on page 17, and "MTX Editor User's Manual."

11. Save your settings and close MTX Editor.

A project file with the extension ".mtx" will be created.

On-site work (Installation and wiring)

Install and connect the system while referring to the schematic diagram you printed out.

1. Install the MTX3, and make the analog audio connections.**2. Make digital connections between the MTX3 and any XMV/EXi8/EXo8.**

Make a ring connection with the devices equipped with a [YDIF] connector.

3. Connect the MTX3 to an analog input amp.**4. Set the UNIT ID of the MTX3 and the XMV/EXi8/EXo8.**

Set the UNIT ID for every MTX3 and XMV/EXi8/EXo8 device you connected in the above steps. The UNIT ID is specified by the combination of the [UNIT ID] rotary switch and DIP switches located on each device's rear panel. Set each device to a different UNIT ID so that no conflict occurs.

5. Make connections between the MTX3 and the DCP units.

Daisy-chain the DCP units. Set the panel ID and termination settings of the DCP units. For details, refer to the DCP owner's manual.

On-site work (Settings in MTX Editor)

Use MTX Editor to make adjustments for the entire system.

1. Connect the computer to the MTX3/XMV/EXi8/EXo8 via a network switch.

If you're using only the MTX3, you can connect it directly to the computer.

2. Start up MTX Editor and load the project file that you previously created.

3. Power-on the MTX3.

4. Power-on the XMV/EXi8/EXo8 and the analog input amps.

5. In the [To Device] direction, place the MTX3/XMV/EXi8/EXo8 and MTX Editor online (in a synchronized state).

“Online” refers to the state in which the MTX3/XMV/EXi8/EXo8 itself is connected with MTX Editor and is synchronized. When the devices are online, MTX Editor can be used to control the MTX3/XMV/EXi8/EXo8. For details on how to put the device online, refer to “MTX Editor User’s Manual.”

6. Check the presets.

Recall a preset, and verify that the settings are correct. For details on presets and how to recall them, refer to “Recalling (switching) presets” on page 17.

7. Check the signal processing.

Input audio signals into the MTX3, and check the meters in MTX Editor to verify that the volume and routing are set correctly.

8. Adjust the output level of the MTX3 and the output level of the amps so that the audio is output from the speakers at an appropriate level.

One by one, turn on each output channel and adjust its output level.

9. Store the preset.

Recall, edit, and save other presets in the same way.

10. Save your settings and close MTX Editor.

A project file with the extension “.mtx” will be created.

NOTE

The settings you make while online are saved in the MTX3 itself, but we recommend that you use MTX Editor to save them as a project file for future maintenance and readjustments.

Various Procedures

Recalling (switching) presets

With the MTX system, input/output port patching, matrix mixer settings, and the parameters of XMV amps within the same MTX system are stored together as a “preset” in the MTX3 and in MTX Editor for recall when desired.

Each MTX system can store 50 presets. MTX Editor is used to edit presets.

Each preset contains settings such as the following.

- Input/output port settings and patching
- Input/output channel gain and EQ settings
- Matrix mixer settings
- Zone settings
- Routing settings
- Effect settings
- DCA and mute group settings
- Parameter settings for XMV devices within the same MTX system
- Preset name

For details, refer to “MTX Editor User’s Manual.”

Switching presets from the MTX3

1. While watching the [PRESET] display, use the [▲]/[▼] buttons to select the preset number that you want to recall.

The [PRESET] display will flash during this time.

2. Press the [ENTER] button to confirm your selection.

The [PRESET] display will stop flashing; the preset has been recalled.

NOTE

- If you leave the device for 30 seconds with the [PRESET] display flashing, it will revert to the previous preset number.
- If a control panel such as a DCP series unit is connected, you’ll be able to easily switch presets.

Setting the clock

Each time the devices connected to the MTX system are brought online, the date and time of the computer will be transmitted to all devices, automatically updating their internal clocks.

You can also update the date and time settings on all devices connected to the same network by transmitting the computer’s date and time settings from the “Clock” dialog box in MTX Editor.

For more information on operation, refer to “MTX Editor User’s Manual.”

Using the scheduler





The scheduler can switch presets or play music and sound effects from the SD memory card at the date and time you specify. Each such setting is called an “event.”

Event settings are made in the “Scheduler” dialog box of MTX Editor. For details on operation, refer to “MTX Editor User’s Manual.”

< Example 1 >

Switching background music and playback area according to the time of day

In commercial facilities that switch background music and playback areas at different times of the day, you can switch the type of music and the playback area according to the time of day.

	9:00	12:00	14:00	18:00	22:00
Indoors	 Refreshing music	 Energetic music	 Calm music	 Atmospheric music	
Outdoors		No music			No music

< Example 2 >

Switching the playback time according to the day of the week

In commercial facilities that switch the time period of music depending on the day of the week, you can specify the music pattern and playback times according to the day of the week and the hours of operation.

• Monday–Friday

	10:00	20:00
	Music pattern 1	

• Saturday

	10:00	22:00
	Music pattern 2	

• Sunday

	12:00	20:00
	Music pattern 3	

You can also play seasonal music, or specify exceptions such as stopping playback on days when the facility is not operating.

Connecting via the [GPI] connector

GPI (General Purpose Interface) devices can be connected to the rear-panel [GPI] connectors. GPI allows a variety of control signals to be exchanged with external controllers or other devices.

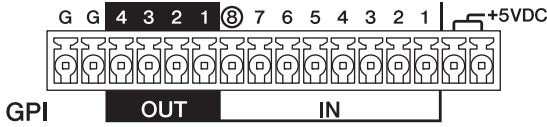

The MTX3 provides 8 input ports and 4 output ports.

- The +5VDC terminals have an output voltage of 5V. The maximum current draw is 100 mA total for the two terminals. If you are using a switch/variable resistor and an LED/relay simultaneously, connect one terminal to the switch/variable resistor and the other terminal to the LED/relay.
- The [IN]-1-7 terminals detect voltage changes from 0V to 5V. The [IN]-8 terminal alone supports +24V input; voltages in the range of 2.5-24V are detected as High, and voltages below 2.5V are detected as Low.
- The [OUT]-1-4 terminals are open collector outputs; they will change between open or closed (Ground). The maximum voltage that can be applied is +12V. The maximum current draw is 75 mA per port.

The GPI controller parameters are assigned via the MTX Editor application.

Euroblock plugs (16-pin) are used for connections to the [GPI] connector. For details, refer to “Euroblock plug connection” on page 12.

NOTE

By making input/output channel settings in MTX Editor, you can recall presets or edit parameters on an external GPI device or send signals to it. For details, refer to the “MTX Editor User’s Manual.”

• Connection examples using the [GPI IN] connector

Example: Controlling the MTX3 from a switch box

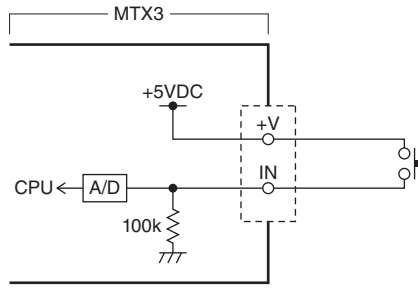

Example: Controlling the MTX3 with a 10k ohm linear taper potentiometer.

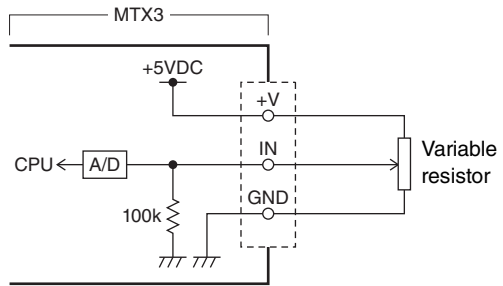

• Connection examples using the [GPI OUT] connector

Example: Lighting LED indicators on external devices from the MTX3

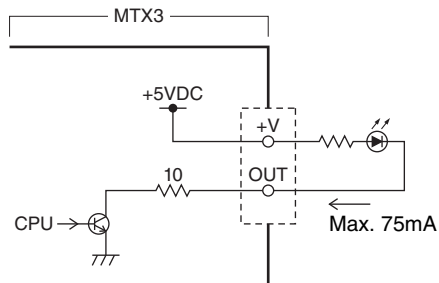

CAUTION

Do not exceed 75 mA of current from the OUT connector.

Example: Lighting an LED by switching an external device’s relay from the MTX3

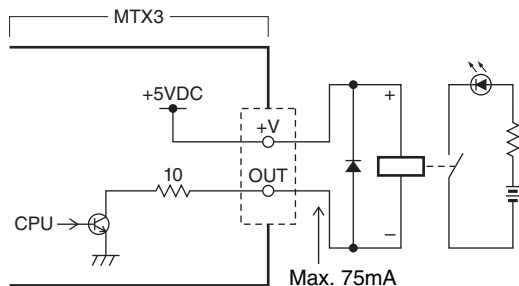

NOTE

For the method of adjusting the detection range of the input voltage at the [GPI] connector (calibration), refer to the “MTX Editor User’s Manual.”

Using the MTX3 to play audio files saved on an SD memory card

The MTX3 can use commercially available SD memory cards to play back audio files such as music and sound effects without needing to connect a CD player or other audio device. The MTX3 can play back audio files in either MP3 or WAV formats.

Here we explain how to handle SD memory cards. In order to play back audio files saved on an SD memory card, you must make settings in MTX Editor. For details, refer to “MTX Editor User’s Manual.”

NOTE

Use an SD format or SDHC format memory card (SDXC format is not supported). However, depending on the manufacturer or type of memory card, some memory cards might not work correctly with the MTX3.

■ Inserting an SD memory card

1. Use a 2.5 mm hex key to open the cover of the SD memory card slot.
2. With the terminals of the SD memory card facing downward, insert the card straight into the slot until it clicks into place.

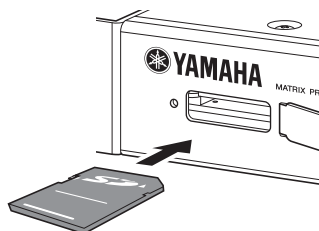

When the SD memory card has been correctly recognized, the [SD/ACT] indicator (page 9) will light. The [SD/ACT] indicator will flash while the card is being accessed.

NOTE

To prevent theft of the SD memory card, we recommend that you leave the cover installed during use.

■ Removing the SD memory card

1. Gently press the SD memory card inward.
The card will pop out slightly; gently pull it completely out.

Initializing the MTX3

Here’s how to initialize the MTX3’s internal memory, restoring it to the factory settings.

1. Power-off the MTX3.
2. Set the rear panel DIP switches 7 and 8 to the “INIT. (INITIALIZE)” position.



3. Power-on the MTX3.

Initialization will start.

The status of execution is shown by the front panel [ALERT] indicator and the various indicators from [NETWORK] through [SD/ACT].

• During initialization:

All indicators from [NETWORK] through [SD/ACT] will flash.

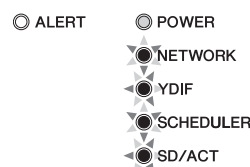

• Initialization completed:

Only the [NETWORK] indicator and the [YDIF] indicator will flash.

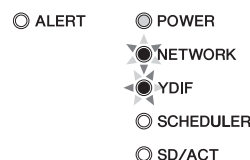

• Initialization failed:

The [ALERT] indicator will flash.

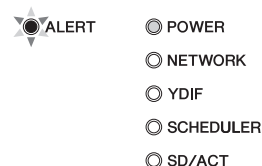

⚠ CAUTION

Do not turn off the power to the MTX3 during initialization. Otherwise, a malfunction may occur.

NOTE

If initialization failed, contact Yamaha representatives / authorized distributors to have the device inspected. A list of Yamaha representatives / authorized distributors appears near the end of this manual.

4. When initialization is completed, power-off the MTX3 once again.

5. Set the rear panel DIP switches 7 and 8 to the “RESUME” position.



6. Power-on the MTX3 again.

The MTX3 will start up in its factory-set state.

Appendix

■ Troubleshooting

The Yamaha Pro Audio website provides a FAQ (a list of frequently asked questions, with answers).
<http://www.yamahaproaudio.com/>

Symptom	Possible cause, and action
The device does not turn on, or the panel LEDs do not light up.	Connect the power cord properly.
	Make sure that the power switch is turned on.
	If the power still does not turn on, contact your Yamaha dealer.
Can't exchange data between the MTX3 and MTX Editor (MTX3 is not shown in MTX Editor).	Is the NETWORK connector on the MTX3 properly connected to your computer?
	Have you specified the correct UNIT ID using the [UNIT ID] rotary switch and DIP switches 1 and 2 on the rear panel? Could the UNIT ID be conflicting with another device?
	Set the rear panel DIP switch 6 (IP SETTING) to "UNIT ID" so that the IP address will be automatically assigned according to the UNIT ID.
No audio input is present. ([INPUT SIGNAL] indicator does not light)	Connect the cable properly.
	Make sure that a signal from an external device is being input.
	Set the gain of the internal head amplifier or external head amplifier to an appropriate level.
No audio is output. ([OUTPUT SIGNAL] indicator does not light)	Could the output level be lowered?
	In MTX Editor, could the channel's ON button be turned off?
	Is the signal routing specified correctly?
	Have the other settings in MTX Editor been made correctly?
The panel controls don't work.	Could rear panel DIP switch 5 (PANEL LOCK) be set to "LOCK"? Change this to "UNLOCK" to defeat the panel lock function. If you are still unable to operate the device, contact your Yamaha dealer.
Can't operate the DCP.	Are you using an appropriate cable, and is the MTX3 correctly connected to the DCP?
	Did you power-cycle the MTX3 after connecting the DCP? The DCP will be detected when the power is turned on.
	Did you assign the DCP's ID and parameters correctly in MTX Editor? Also, did you specify a DCP library item in the "Preset" dialog box as the preset to be recalled?
	Is termination turned on for the last-connected DCP?
	Could nine or more DCP units be connected? A maximum of eight DCP units can be connected to one MTX3.
Could the total cable length from the MTX3 to the last control panel be exceeding 200 meters?	
The DCP's LEDs are dim.	Did you set the DCP's LED brightness appropriately in MTX Editor?
[YDIF] indicator does not light.	Did you use an appropriate cable to make proper YDIF connections between the MTX3 and other devices in the MTX system? Also, is the power to the YDIF-connected devices turned on?
Can't play audio files from the SD memory card.	Is the SD memory card recognized correctly? Make sure that the front panel [SD/ACT] indicator is lit or flashing.
	In MTX Editor, have you made the correct settings for SD memory card playback and for the scheduler?
	Are playable audio files saved in the specified folder?
SD memory card is not detected.	Are you using an SD memory card type and format that is supported? Refer to the "Specifications" page, and use a supported card.
	Is the SD memory card inserted correctly? Turn off the power of the MTX3, re-insert the card, and then turn the power on again. If the [SD/ACT] indicator does not light and the card is not detected, it may be that the card is damaged.
Preset does not switch at the time specified by the scheduler.	The MTX3's clock is set by sending clock data from the computer via MTX Editor to the MTX3. Make sure that the computer's clock is set correctly.
	Have you made the correct scheduler settings in MTX Editor? If the [SCHEDULER] indicator is not lit or flashing, it may be that settings were not made correctly in MTX Editor.
The [ALERT] indicator is flashing.	An error has occurred. The alert number is shown in the front panel [PRESET] display; refer to "Alert list" on page 22 to determine the content of the error and take the appropriate action.
Can't switch presets from a device connected to the [GPI] connector.	Is the GPI device connected correctly?
	Have the correct GPI-related settings been made in MTX Editor?
Volume becomes unstable when it is operated from a device connected to the [GPI] connector.	Route the wiring to avoid picking up noise; for example, replace the cable with a shielded or shorter cable.

■ Alert list

This is a list of the alerts that may be indicated in the front panel [PRESET] display.

Alert number	Meaning	Response
01–09	The device has not started up correctly.	Turn the power off, then turn on after waiting at least 6 seconds. If this does not solve the problem, please initialize the memory (use rear panel DIP switches 7 and 8). Should this also fail, contact your Yamaha dealer.
10	The internal backup battery has been completely exhausted or is not installed.	When you turn off the power, the current settings will be lost, and will return to the default values. Please stop use immediately, and contact your Yamaha dealer.
11	The internal backup battery has run extremely low, and it is possible that the internal memory has been cleared.	When you turn off the power, the current settings will be lost, and will return to the default values. Please stop use immediately, and contact your Yamaha dealer.
12	The internal backup battery has only a small amount of power remaining.	This does not affect the operation of the device. However, if you continue using the device, the settings may be lost and reset to the default values. Contact your Yamaha dealer as soon as possible.
13	A problem has occurred with the internal clock, and it has been initialized (January 1, 2000, 0:00).	If this occurs each time you turn on the power, it is possible that the internal backup battery has run down or that the device has malfunctioned. Contact your Yamaha dealer. If this occurs only once, an abnormality was detected with the clock setting and it was initialized; use MTX Editor to set the time.
14	The current preset saved in internal memory has been lost.	Recall the preset. If this does not solve the problem, contact your Yamaha dealer.
15	The settings saved in internal memory have been lost.	Either the internal backup battery has run low, or the device has malfunctioned. Contact your Yamaha dealer.
21	The word clock master has become unlocked.	Make sure that the word clock signal is being input correctly.
22	The digital signal being input to the [YDIF IN] connector is not synchronized to the word clock of this device.	Make sure that YDIF cables are properly connected. Use cables that meet the required specifications.
23	The digital signal being input to the [YDIF IN] connector is not continuously synchronized to the word clock of this device.	
30	There is a problem with the connection of the [YDIF IN] connector.	
40	Duplicate IP addresses.	Change the IP addresses so that there are no duplicates.
41	IP address was not set within 60 seconds of startup.	Please check rear panel DIP switch 6 (IP Setting). If DIP switch 6 is set to "PC," use MTX Editor or DHCP server to specify the device IP address.
42	A device within the MTX system was not found on the network.	Power-on all devices in the system, and make sure that they are correctly connected to the network.
43	Too many devices are connected to the network.	Reduce the number of devices connected to the network.
50	The UNIT ID is set to "00."	Set the UNIT ID to something other than "00."
51	Devices with identical UNIT IDs were found connected within the same network.	Change the UNIT ID so that there are no duplicates.
52	A communication error occurred with the [DCP] connection.	<ul style="list-style-type: none"> • If an error was shown in the DCP panel, refer to the DCP owner's manual and take the appropriate action. • Ensure that the panel ID of the DCP units do not conflict. • Verify that the cables are correctly connected and are within the specified length.
53	The DCP connected to the [DCP] connector has been configured differently from the project settings.	<ul style="list-style-type: none"> • Check that the required DCP is connected. • Check whether a different model of DCP might be connected.
56	SD memory card was not recognized.	Use an SD memory card that complies with the specifications. (See page 23.)
58	Unable to play the specified file or folder in the SD player.	Verify that the specified audio file or folder exists in the SD memory card. There must be at least one playable audio file in the specified folder.
60	A preset recall attempt has failed.	Initialize the memory of the device (use rear panel DIP switches 7 and 8). If this does not solve the problem, contact your Yamaha dealer.
61	The recall could not be executed because the preset to be recalled when the MTX starts up was not found.	Specify a preset that exists. No sound will be output unless an appropriate preset is recalled.
64	The preset could not be recalled.	<ul style="list-style-type: none"> • The Preset selected for recall cannot be recalled as no data has been stored to it. • Another device may have been added after presets were stored. Please synchronize and check all presets using MTX Editor, edit as necessary and store again.
70	Synchronization has not been completed. It may be that synchronization was halted before completion.	Perform synchronization again using MTX Editor. If this does not solve the problem, initialize the memory of the device and synchronize again. If this also fails, contact your Yamaha dealer.
71	The UNIT ID settings when synchronization was performed do not match the current UNIT ID settings.	Do not change any UNIT ID's after performing synchronization. If you've changed any UNIT ID's, perform synchronization again.

■ Specifications

Product specifications	
Dimensions (W x H x D)	480(W) x 44(H) x 351(D)mm, 1U
Weight	4.8 kg
Power supply voltage	Japan: 100V 50/60Hz US/Canada: 110V–240V 50/60Hz Others: 100V–240V 50/60Hz
Power consumption	50W max.
Heat dissipation (per hour)	43kcal max.
Operating temperature range	0 °C–40 °C
Storage temperature range	-20 °C–60 °C
NC value	27 (1m from the front panel)
Number of memories	Preset memories: 50
Maximum number of simultaneously usable devices	Four MTX devices (However in a system in which one to four MTX devices are connected, a total of up to 20 devices including devices such as the XMV can be connected.)
Power cord length	2.5m
Included items	Power cord, Euroblock plugs (3-pin, tabbed) x 16, Euroblock plug (16-pin) x 1, cable ties x 16, owner's manual
Separately sold options	DCP1V4S-US/EU, DCP4V4S-US/EU, DCP4S-US/EU digital control panels

Electrical specifications	
Sampling frequency	48 kHz
Signal delay	Less than 2.5ms (AD-DA @48kHz)
Frequency response	20Hz to 20kHz, -1.5dB min, 0dB typ., +0.5dB max.
Total harmonic distortion	Less than 0.05% (+4dBu, Gain:-6dB); less than 0.1% (+4dBu, Gain:+66dB)
Dynamic range	107dB (Gain:-6dB)
Equivalent input noise (EIN)	-126dBu (Gain: +66dB)
Crosstalk / Channel separation	-100dB (@1kHz)
Maximum cable length	[YDIF] connector: 30 meters (Cable length between devices) [DCP] connector: 200 meters (total cable length from the MTX3 to the last DCP)
Indicators	INPUT PEAK: RED -3dBFS INPUT SIGNAL: GREEN -40dBFS OUTPUT SIGNAL: GREEN -40dBFS
Phantom power	48V (per channel; individually settable)

Connector specifications	
Format	[GPI] connector: IN (1-7ch): 0–5V IN (8ch): 2.5–24V : High, 2.5V or less: Low, Allowable input +24V OUT: Open collector +V: DC5V NETWORK connector: 100Base-TX [RS-232C] connector: RS-232C (BAUD RATE: 38.4 kbps/115.2kbps)
Cable specifications	[DCP] connector: CAT5e or better Ethernet cable (Straight connected. All 8 pins must be connected.) [YDIF] connector: CAT5e or better Ethernet STP cable (Straight connected. All 8 pins must be connected.) NETWORK connector: CAT5e or better Ethernet STP cable

SD Memory card specifications	
Supported formats	File formats: FAT32, FAT16, FAT12 Files created on a computer running Windows XP or later, or Mac OS X or later.
Supported capacities	Maximum media capacity: SDHC: Max. 32 GB SD: Max. 2GB
Maximum file size (maximum size per file)	FAT12: Max. 32MB FAT16: Max. 2GB FAT32: Max. 2GB
Audio file format: WAV	16bit 2ch PCM Sampling frequencies: 8kHz, 11.025kHz, 12kHz, 16kHz, 22.05kHz, 24kHz, 32kHz, 44.1kHz, 48kHz
Audio file format: MP3	MPEG-1/2/2.5 Audio Layer-3 sampling frequencies: MPEG-1: 32kHz, 44.1kHz, 48kHz MPEG-2: 16kHz, 22.05kHz, 24kHz MPEG-2.5: 8kHz, 11.025kHz Bit rate: MPEG-1: 32kbps–320kbps, VBR (Variable Bit Rate) * However, free format is excepted. MPEG-2, 2.5: 8 kbps–160 kbps, VBR (Variable Bit Rate) *However, free format is excepted.

* Specifications and appearance are subject to change without notice for improvement.

European Models

Inrush Current based on EN 55103-1: 2009
2A (on initial switch-on)
2A (after a supply interruption of 5s)
Conforms to Environments: E1, E2, E3 and E4

■ Input/Output Characteristics

ANALOG INPUT CHARACTERISTICS

Input Terminals	GAIN	Actual Load Impedance	For Use With Nominal	Input Level		Connector
				Nominal	Max. before clip	
INPUT 1–8	+66dB	10kΩ	50–600Ω Mics & 600Ω Lines	-62dBu (0.616mV)	-42dBu (6.16mV)	Euroblock (Balanced) (5.08mm pitch)
	-6dB			+10dBu (2.45V)	+30dBu (24.5V)	
ST IN 1, 2	—	10kΩ	600Ω Lines	-10dBV (316mV)	+10dBV (3.16V)	RCA Pin Jack

- In these specifications, 0dBu = 0.775 Vrms., 0dBV = 1.00 Vrms.
- All input AD converters are 24bit linear, 128times oversampling.
- +48V DC (phantom power) is supplied to INPUT EUROBLOCK connectors via each individual software controlled switch.

ANALOG OUTPUT CHARACTERISTICS

Output Terminals	Actual Source Impedance	For Use With Nominal	Output Level		Connector
			Nominal	Max. before clip	
OUTPUT 1–8	75Ω	10kΩ Lines	+4dBu (1.23 V)	+24dBu (12.3V)	Euroblock (Balanced) (5.08mm pitch)

- In these specifications, 0dBu = 0.775 Vrms.
- All output DA converters are 24bit, 128times oversampling.

■ Dimensions

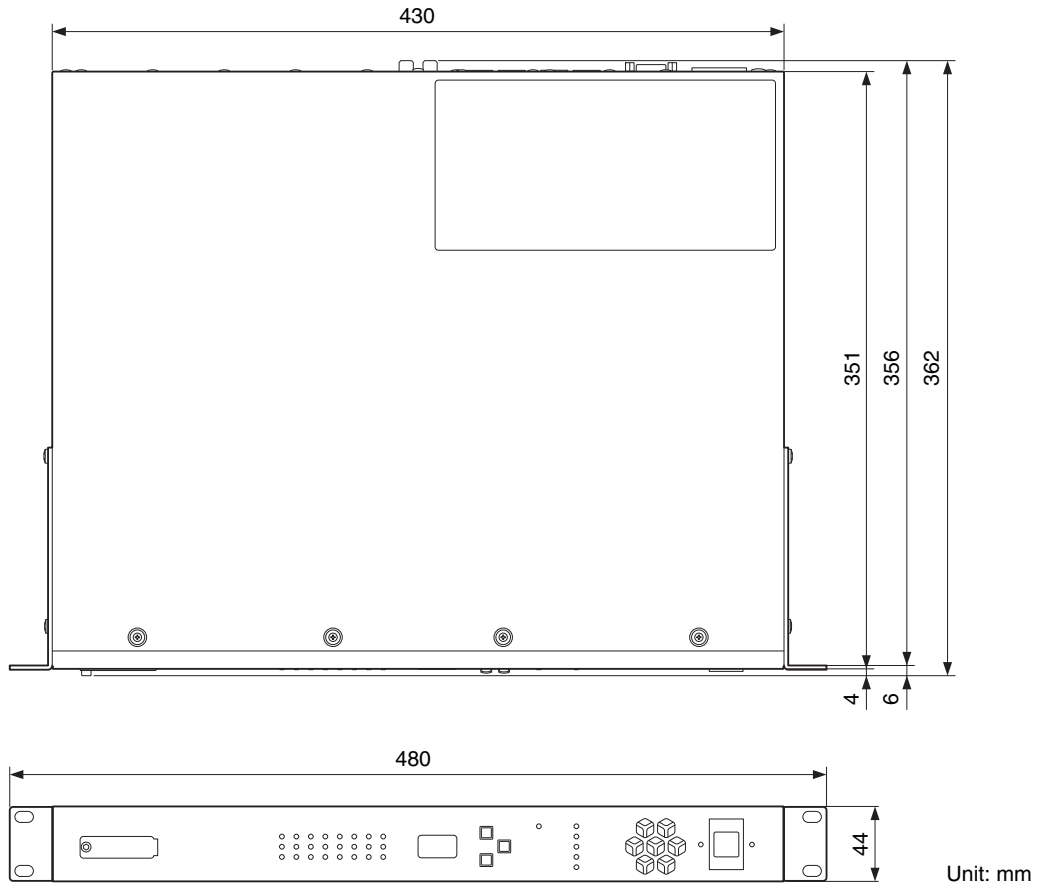

Block Diagram

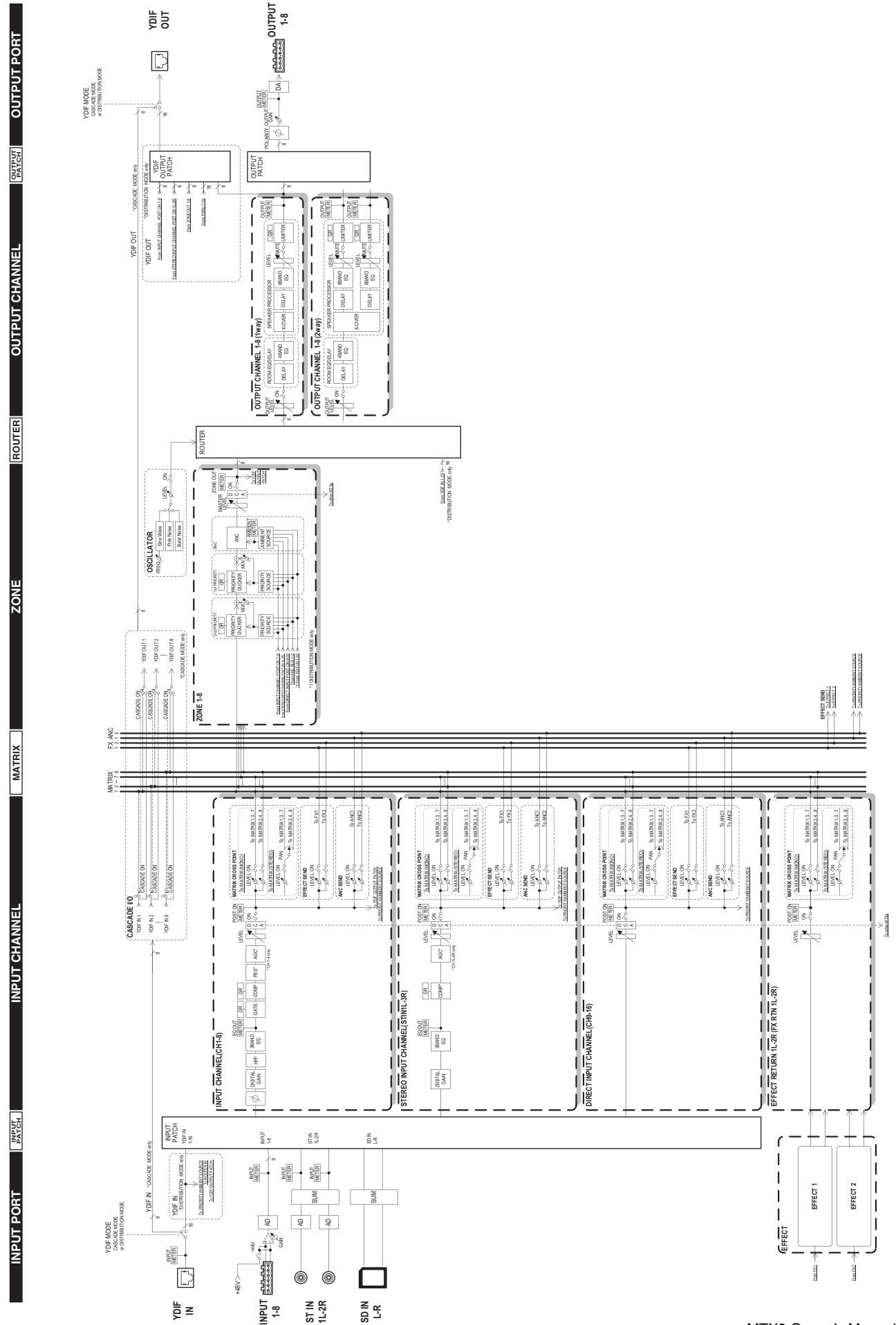

■ Index

Symbols

+48V	11
[▲/▼] buttons	9
[ALERT] indicator	9
[DCP] connector	10
[ENTER] button	9
[GPI] connector	10
[INPUT PEAK] indicator	9
[INPUT SIGNAL] indicator	9
[INPUT] connectors	11
[NETWORK] indicator	9
[OUTPUT SIGNAL] indicator	9
[OUTPUT] connectors	11
[POWER] indicator	9
[PRESET] display	9
[RS-232C] connector	10
[SCHEDULER] indicator	9
[SD/ACT] indicator	9
[ST IN] connectors	11
[UNIT ID] rotary switch	10
[YDIF] connector	11
[YDIF] indicator	9
A AC IN connector	10
Alert	9, 22
B Block Diagram	25
C cable ties	7, 12
Cascade mode	14
control panel	8
Controls and Connectors	9
D DCP	8
DIP switch	10
Distribution mode	14
E Euroblock plug	7, 10, 11, 12
event	17
F Features	8
Front Panel	9
G Ground screw	10
I INIT. (INITIALIZE)	11
Initializing	19
install	14
IP address	11
IP SETTING	11
L LOCK	11
M MTX Editor	8
N NETWORK connector	10
O online	16
P PANEL LOCK	11
PC	11
phantom power	11
Power switch	9
preset	8, 9, 15, 16
project file	15, 16
Q Quick Guide	14
R Rear Panel	10
RESUME	11
S scheduler	17
schematic diagram	14
SD memory card	9, 19
SD memory card slot	9, 19
START UP MODE	11
store	15
subnet mask	14
U UNIT ID	9, 10
UNLOCK	11
W wizard	14
Y YDIF	8

Important Notice: Guarantee Information for customers in European Economic Area (EEA) and Switzerland

<p>Important Notice: Guarantee Information for customers in EEA* and Switzerland</p> <p>For detailed guarantee information about this Yamaha product, and Pan-EEA* and Switzerland warranty service, please either visit the website address below (Printable file is available at our website) or contact the Yamaha representative office for your country. * EEA: European Economic Area</p>	English
<p>Wichtiger Hinweis: Garantie-Information für Kunden in der EWR* und der Schweiz</p> <p>Für nähere Garantie-Information über dieses Produkt von Yamaha, sowie über den Pan-EWR* und Schweizer Garantieservice, besuchen Sie bitte entweder die folgend angegebene Internetadresse (eine druckfähige Version befindet sich auch auf unserer Webseite), oder wenden Sie sich an den für Ihr Land zuständigen Yamaha-Vertrieb. *EWR: Europäischer Wirtschaftsraum</p>	Deutsch
<p>Remarque importante: informations de garantie pour les clients de l'EEE et la Suisse</p> <p>Pour des informations plus détaillées sur la garantie de ce produit Yamaha et sur le service de garantie applicable dans l'ensemble de l'EEE ainsi qu'en Suisse, consultez notre site Web à l'adresse ci-dessous (le fichier imprimable est disponible sur notre site Web) ou contactez directement Yamaha dans votre pays de résidence. * EEE : Espace Economique Européen</p>	Français
<p>Belangrijke mededeling: Garantie-informatie voor klanten in de EER* en Zwitserland</p> <p>Voor gedetailleerde garantie-informatie over dit Yamaha-product en de garantieservice in heel de EER* en Zwitserland, gaat u naar de onderstaande website (u vindt een afdrukbaar bestand op onze website) of neemt u contact op met de vertegenwoordiging van Yamaha in uw land. * EER: Europese Economische Ruimte</p>	Nederlands
<p>Aviso importante: información sobre la garantía para los clientes del EEE* y Suiza</p> <p>Para una información detallada sobre este producto Yamaha y sobre el soporte de garantía en la zona EEE* y Suiza, visite la dirección web que se incluye más abajo (la versión del archivo para imprimir esta disponible en nuestro sitio web) o póngase en contacto con el representante de Yamaha en su país. * EEE: Espacio Económico Europeo</p>	Español
<p>Avviso importante: informazioni sulla garanzia per i clienti residenti nell'EEA* e in Svizzera</p> <p>Per informazioni dettagliate sulla garanzia relativa a questo prodotto Yamaha e l'assistenza in garanzia nei paesi EEA* e in Svizzera, potete consultare il sito Web all'indirizzo riportato di seguito (è disponibile il file in formato stampabile) oppure contattare l'ufficio di rappresentanza locale della Yamaha. * EEA: Area Economica Europea</p>	Italiano
<p>Aviso importante: informações sobre as garantias para clientes da AEE* e da Suíça</p> <p>Para obter uma informação pormenorizada sobre este produto da Yamaha e sobre o serviço de garantia na AEE* e na Suíça, visite o site a seguir (o arquivo para impressão está disponível no nosso site) ou entre em contato com o escritório de representação da Yamaha no seu país. * AEE: Área Econômica Européia</p>	Português
<p>Σημαντική σημείωση: Πληροφορίες εγγύησης για τους πελάτες στον ΕΟΧ* και Ελλάδα</p> <p>Για λεπτομερείς πληροφορίες εγγύησης σχετικά με το παρόν προϊόν της Yamaha και την κάλυψη εγγύησης σε όλες τις χώρες του ΕΟΧ και την Ελλάδα, επισκεφτείτε την παρακάτω ιστοσελίδα (Εκτυπώσιμη μορφή είναι διαθέσιμη στην ιστοσελίδα μας) ή απευθυνθείτε στην αντιπροσωπεία της Yamaha στη χώρα σας. * ΕΟΧ: Ευρωπαϊκός Οικονομικός Χώρος</p>	Ελληνικά
<p>Viktigt: Garantiinformation för kunder i EES-området* och Schweiz</p> <p>För detaljerad information om denna Yamahaprodukt samt garantiservice i hela EES-området* och Schweiz kan du antingen besöka nedanstående webbadress (en utskriftsvänlig fil finns på webbplatsen) eller kontakta Yamahas officiella representant i ditt land. * EES: Europeiska Ekonomiska Samarbetsområdet</p>	Svenska
<p>Viktig merknad: Garantiinformasjon for kunder i EØS* og Sveits</p> <p>Detaljert garantiinformasjon om dette Yamaha-produktet og garantiservice for hele EØS-området* og Sveits kan fås enten ved å besøke nettstedene nedenfor (utskriftsversjon finnes på våre nettsider) eller kontakte Yamahas kontoret i landet der du bor. *EØS: Det europeiske økonomiske samarbeidsområdet</p>	Norsk
<p>Vigtig oplysning: Garantioplysninger til kunder i EØ* og Schweiz</p> <p>De kan finde detaljerede garantioplysninger om dette Yamaha-produkt og den fælles garantiserviceordning for EØ* (og Schweiz) ved at besøge det websted, der er angivet nedenfor (der findes en fil, som kan udskrives, på vores websted), eller ved at kontakte Yamahas nationale repræsentationskontor i det land, hvor De bor. * EØ: Det Europæiske Økonomiske Område</p>	Dansk
<p>Tärkeä ilmoitus: Takuutiedot Euroopan talousalueen (ETA)* ja Sveitsin asiakkaille</p> <p>Tämän Yamaha-tuotteen sekä ETA-alueen ja Sveitsin takuuta koskevat yksityiskohtaiset tiedot saatte alla olevasta nettiosoitteesta. (Tulostettava tiedosto saatavissa sivustollamme.) Voitte myös ottaa yhteyttä paikalliseen Yamaha-edustajaan. *ETA: Euroopan talousalue</p>	Suomi
<p>Ważne: Warunki gwarancyjne obowiązujące w EOG* i Szwajcarii</p> <p>Aby dowiedzieć się więcej na temat warunków gwarancyjnych tego produktu firmy Yamaha i serwisu gwarancyjnego w całym EOG* i Szwajcarii, należy odwiedzić wskazaną poniżej stronę internetową (Plik gotowy do wydruku znajduje się na naszej stronie internetowej) lub skontaktować się z przedstawicielstwem firmy Yamaha w swoim kraju. * EOG — Europejski Obszar Gospodarczy</p>	Polski
<p>Důležité oznámení: Záruční informace pro zákazníky v EHS* a ve Švýcarsku</p> <p>Podrobné záruční informace o tomto produktu Yamaha a záručním servisu v celém EHS* a ve Švýcarsku naleznete na níže uvedené webové adrese (soubor k tisku je dostupný na našich webových stránkách) nebo se můžete obrátit na zastoupení firmy Yamaha ve své zemi. * EHS: Evropský hospodářský prostor</p>	Česky
<p>Fontos figyelemzétetés: Garancia-információk az EGT* területén és Svájcban élő vásárlók számára</p> <p>A jelen Yamaha termékre vonatkozó részletes garancia-információk, valamint az EGT*-re és Svájcra kiterjedő garanciális szolgáltatás tekintetében keresse fel webhelyünket az alábbi címen (a webhelyen nyomtatható fájl is talál), vagy pedig lépjen kapcsolatba az országában működő Yamaha képviselői irodával. * EGT: Európai Gazdasági Térség</p>	Magyar
<p>Oluline märkus: Garantiiteave Euroopa Majanduspiirkonna (EMP)* ja Šveitsi klientidele</p> <p>Täpsema teabe saamiseks selle Yamaha toote garantii ning kogu Euroopa Majanduspiirkonna ja Šveitsi garantiiteeninduse kohta, külastage palun veebisaiti alljärgneval aadressil (meie saidil on saadaval printitav fail) või pöörduge Teie regiooni Yamaha esinduse poole. * EMP: Euroopa Majanduspiirkond</p>	Eesti keel
<p>Svarīgs paziņojums: garantijas informācija klientiem EEZ* un Šveicē</p> <p>Lai saņemtu detalizētu garantijas informāciju par šo Yamaha produktu, kā arī garantijas apkalpošanu EEZ* un Šveicē, lūdzu, apmeklējiet zemāk norādīto tīmekļa vietnes adresi (tīmekļa vietnē ir pieejams drukājams fails) vai sazinieties ar jūsu valsti apkalpojošo Yamaha pārstāvniecību. * EEZ: Eiropas Ekonomikas zona</p>	Latviešu
<p>Děmesio: informacija dėl garantijos pirkėjams EEE* ir Šveicarijoje</p> <p>Jei reikia išsamios informacijos apie šį „Yamaha“ produktą ir jo techninę priežiūrą visoje EEE* ir Šveicarijoje, apsilankykite mūsų svetainėje toliau nurodytu adresu (svetainėje yra spausdintinas failas) arba kreipkitės į „Yamaha“ atstovybę savo šaliai. *EEE – Europos ekonominė erdvė</p>	Lietuvių kalba
<p>Dôležité upozornenie: Informácie o záruke pre zákazníkov v EHP* a Švajčiarsku</p> <p>Podrobné informácie o záruke týkajúce sa tohto produktu od spoločnosti Yamaha a garancnom servise v EHP* a Švajčiarsku nájdete na webovej stránke uvedenej nižšie (na našej webovej stránke je k dispozícii súbor na tlač) alebo sa obráťte na zástupcu spoločnosti Yamaha vo svojej krajine. * EHP: Európsky hospodársky priestor</p>	Slovenčina
<p>Pomembno obvestilo: Informacije o garanciji za kupce v EGP* in Švici</p> <p>Za podrobnejše informacije o tem Yamahinem izdelku ter garancijskem servisu v celotnem EGP in Švici, obiščite spletno mesto, ki je navedeno spodaj (natisljiva datoteka je na voljo na našem spletnem mestu), ali se obrnite na Yamahinega predstavnika v svoji državi. * EGP: Evropski gospodarski prostor</p>	Slovenščina
<p>Важно съобщение: Информация за гаранцията за клиенти в ЕИП* и Швейцария</p> <p>За подробна информация за гаранцията за този продукт на Yamaha и гаранционното обслужване в паневропейската зона на ЕИП* и Швейцария или посетете посочения по-долу уеб сайт (на нашия уеб сайт има файл за печат), или се свържете с представителния офис на Yamaha във вашата страна. * ЕИП: Европейско икономическо пространство</p>	Български език
<p>Notificare importantă: Informații despre garanție pentru clienții din SEE* și Elveția</p> <p>Pentru informații detaliate privind acest produs Yamaha și serviciul de garanție Pan-SEE* și Elveția, vizitați site-ul la adresa de mai jos (fișierul imprimabil este disponibil pe site-ul nostru) sau contactați biroul reprezentanței Yamaha din țara dumneavoastră. * SEE: Spațiul Economic European</p>	Limba română

<http://europe.yamaha.com/warranty/>

For details of products, please contact your nearest Yamaha representative or the authorized distributor listed below.

Pour plus de détails sur les produits, veuillez-vous adresser à Yamaha ou au distributeur le plus proche de vous figurant dans la liste suivante.

Die Einzelheiten zu Produkten sind bei Ihrer unten aufgeführten Niederlassung und bei Yamaha Vertragshändlern in den jeweiligen Bestimmungsländern erhältlich.

Para detalles sobre productos, contacte su tienda Yamaha más cercana o el distribuidor autorizado que se lista debajo.

NORTH AMERICA

CANADA

Yamaha Canada Music Ltd.
135 Milner Avenue, Toronto, Ontario,
M1S 3R1, Canada
Tel: 416-298-1311

U.S.A.

Yamaha Corporation of America
6600 Orangethorpe Avenue, Buena Park, CA 90620,
U.S.A.
Tel: 714-522-9011

CENTRAL & SOUTH AMERICA

MEXICO

Yamaha de México, S.A. de C.V.
Av. Insurgentes Sur 1647 Piso 9, Col. San José
Insurgentes, Delegación Benito Juárez, México, D.F.,
C.P. 03900
Tel: 55-5804-0600

BRAZIL

Yamaha Musical do Brasil Ltda.
Rua Joaquim Floriano, 913 - 4º andar, Itaim Bibi, CEP
04534-013 São Paulo, SP. BRAZIL
Tel: 011-3704-1377

ARGENTINA

**Yamaha Music Latin America, S.A.,
Sucursal Argentina**
Olga Cossetini 1553, Piso 4 Norte,
Madero Este-C1107CEK
Buenos Aires, Argentina
Tel: 011-4119-7000

VENEZUELA

**Yamaha Music Latin America, S.A.,
Sucursal Venezuela**
C.C. Manzanares Plaza P4
Ofic. 0401- Manzanares-Baruta
Caracas Venezuela
Tel: 58-212-943-1877

PANAMA AND OTHER LATIN

AMERICAN COUNTRIES/ CARIBBEAN COUNTRIES

Yamaha Music Latin America, S.A.
Torre Banco General, Piso No.7, Marbella,
Calle 47 y Aquilino de la Guardia,
Ciudad de Panamá, República de Panamá
Tel: +507-269-5311

EUROPE

THE UNITED KINGDOM/IRELAND

Yamaha Music Europe GmbH (UK)
Sherbourne Drive, Tilbrook, Milton Keynes,
MK7 8BL, U.K.
Tel: 01908-366700

GERMANY

Yamaha Music Europe GmbH
Siemensstraße 22-34, 25462 Rellingen, Germany
Tel: 04101-3030

SWITZERLAND/LIECHTENSTEIN

**Yamaha Music Europe GmbH
Branch Switzerland in Zürich**
Seefeldstrasse 94, 8008 Zürich, Switzerland
Tel: 044-387-8080

AUSTRIA/BULGARIA

Yamaha Music Europe GmbH Branch Austria
Schleiergasse 20, A-1100 Wien, Austria
Tel: 01-60203900

CZECH REPUBLIC/HUNGARY/ ROMANIA/SLOVAKIA/SLOVENIA

**Yamaha Music Europe GmbH
Branch Austria (Central Eastern Europe Office)**
Schleiergasse 20, A-1100 Wien, Austria
Tel: 01-60203900

POLAND/LITHUANIA/LATVIA/ESTONIA

**Yamaha Music Europe GmbH
Branch Poland Office**
ul. Wrotkowa 14 02-553 Warsaw, Poland
Tel: 022-500-2925

MALTA

Olimpus Music Ltd.
The Emporium, Level 3, St. Louis Street Msida
MSD06
Tel: 02133-2144

NETHERLANDS/BELGIUM/LUXEMBOURG

Yamaha Music Europe Branch Benelux
Clarissenhof 5-b, 4133 AB Vianen, Netherlands
Tel: 0347-358 040

FRANCE

Yamaha Music Europe
7 rue Ambroise Croizat, Zone d'activités Pariest,
77183 Croissy-Beaubourg, France
Tel: 01-64-61-4000

ITALY

Yamaha Music Europe GmbH, Branch Italy
Viale Italia 88, 20020 Lainate (Milano), Italy
Tel: 02-935-771

SPAIN/PORTUGAL

**Yamaha Music Europe GmbH Ibérica, Sucursal en
España**
Ctra. de la Coruna km. 17,200, 28231
Las Rozas (Madrid), Spain
Tel: +34-91-639-88-88

GREECE

Philippos Nakas S.A. The Music House
147 Skiathou Street, 112-55 Athens, Greece
Tel: 01-228 2160

SWEDEN/FINLAND/ICELAND

**Yamaha Music Europe GmbH Germany filial
Scandinavia**
J. A. Wettergrensgata 1, Box 30053
S-400 43 Göteborg, Sweden
Tel: +46 31 89 34 00

DENMARK

**Yamaha Music Europe GmbH, Tyskland – filial
Denmark**
Generatorvej 6A, DK-2730 Herlev, Denmark
Tel: 44 92 49 00

NORWAY

**Yamaha Music Europe GmbH Germany -
Norwegian Branch**
Grini Næringspark 1, N-1361 Østerås, Norway
Tel: 67 16 78 00

RUSSIA

Yamaha Music (Russia) LLC.
Room 37, bld. 7, Kievskaya street, Moscow,
121059, Russia
Tel: 495 626 5005

OTHER EUROPEAN COUNTRIES

Yamaha Music Europe GmbH
Siemensstraße 22-34, 25462 Rellingen, Germany
Tel: +49-4101-3030

AFRICA

Yamaha Music Gulf FZE
Office JAFZA 16-512, P.O.Box 17328,
Jebel Ali - Dubai, UAE
Tel: +971-4-881-5868

MIDDLE EAST

TURKEY

**Yamaha Music Europe GmbH
Merkezi Almanya Türkiye İstanbul Şubesi**
Maslak Meydan Sokak No:5 Spring Giz Plaza
Bağimsiz Bol. No:3, 34398 Şişli İstanbul
Tel: +90-212-999-8010

CYPRUS

Yamaha Music Europe GmbH
Siemensstraße 22-34, 25462 Rellingen, Germany
Tel: 04101-3030

OTHER COUNTRIES

Yamaha Music Gulf FZE
Office JAFZA 16-512, P.O.Box 17328,
Jebel Ali - Dubai, U.A.E
Tel: +971-4-881-5868

ASIA

THE PEOPLE'S REPUBLIC OF CHINA

Yamaha Music & Electronics (China) Co.,Ltd.
2F, Yunhedasha, 1818 Xinzha-lu, Jingan-qu,
Shanghai, China
Tel: 021-6247-2211

INDIA

Yamaha Music India Pvt. Ltd.
Spazedge building, Ground Floor, Tower A, Sector 47,
Gurgaon- Sohna Road, Gurgaon, Haryana, India
Tel: 0124-485-3300

INDONESIA

PT. Yamaha Musik Indonesia (Distributor)
Yamaha Music Center Bldg. Jalan Jend. Gatot Subroto
Kav. 4, Jakarta 12930, Indonesia
Tel: 021-520-2577

KOREA

Yamaha Music Korea Ltd.
8F, 9F, Dongsung Bldg. 158-9 Samsung-Dong,
Kangnam-Gu, Seoul, Korea
Tel: 02-3467-3300

MALAYSIA

Yamaha Music (Malaysia) Sdn., Bhd.
No.8, Jalan Perbandaran, Kelana Jaya, 47301
Petaling Jaya, Selangor, Malaysia
Tel: 03-78030900

SINGAPORE

Yamaha Music (Asia) Private Limited
Block 202 Hougang Street 21, #02-00,
Singapore 530202, Singapore
Tel: 65-6747-4374

TAIWAN

Yamaha Music & Electronics Taiwan Co.,Ltd.
3F, No.6, Section 2 Nan-Jing East Road, Taipei,
Taiwan R.O.C.
Tel: 02-2511-8688

THAILAND

Siam Music Yamaha Co., Ltd.
3, 4, 15 and 16th floor, Siam Motors Building,
891/1 Rama 1 Road, Wangmai,
Pathumwan, Bangkok 10330, Thailand
Tel: 02-215-2622

VIETNAM

Yamaha Music Vietnam Company Limited
15th Floor, Nam A Bank Tower, 201-203 Cach Mang
Thang Tam St., Ward 4, Dist.3,
Ho Chi Minh City, Vietnam
Tel: +84-8-3818-1122

OTHER ASIAN COUNTRIES

**Yamaha Corporation
Sales & Marketing Division**
Nakazawa-cho 10-1, Naka-ku, Hamamatsu,
Japan 430-8650
Tel: +81-53-460-2312

OCEANIA

AUSTRALIA

Yamaha Music Australia Pty. Ltd.
Level 1, 99 Queensbridge Street, Southbank,
Victoria 3006, Australia
Tel: 3-9693-5111

COUNTRIES AND TRUST

TERRITORIES IN PACIFIC OCEAN

**Yamaha Corporation
Sales & Marketing Division**
Nakazawa-cho 10-1, Naka-ku, Hamamatsu,
Japan 430-8650
Tel: +81-53-460-2312